

# CGA

portails aluminium

- PORTAILS BATTANTS
- PORTAILS COULISSANTS
- PORTAILS STYLE FERRONNERIE
- CLÔTURES
- GARDE-CORPS
- VOILETS BATTANTS



CATALOGUE





## Les tôles de remplissage

6 modèles de tôles perforées au choix



217.206

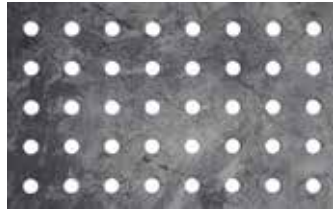

217.207



217.208

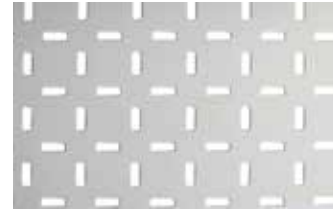

217.209



217.214



217.218

## Les couleurs de remplissage

8 nuances d'aspect bois ou de métaux patinés



Wengé



Poirier foncé



Noyer foncé



Teck



Chêne antique



Chêne cérusé blanc



Terre de sable



Galva améthyste

9 teintes lisses selon RAL

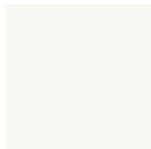

Blanc pur  
RAL 9010



Ivoire clair  
RAL 1015 Sat



Gris anthracite  
RAL 7016 Sat

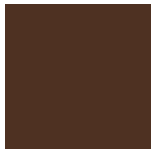

Brun  
RAL 477 Sat



Vert mousse  
RAL 6005 sat



Bleu pigeon  
RAL 5014 Sat



Bleu gentiane  
RAL 5010 Sat



Rouge pourpre  
RAL 3004 Sat



Vert pâle  
RAL 6021 Sat

13 teintes Terra Cigala au toucher granité unique



Dune



Sable



Bleu de  
Provence



Bleu antique



Rouge basque



Rouille



Sienna



Vert de  
Provence



Vert antique



Vert amazone



Gris argent

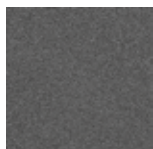

Gris antique

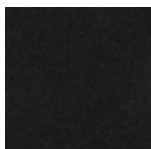

Noir bazalt



## Le design des lames

7 modèles de lames pour les portails et portillons



217.926



211.020



217.024



217.925



211.022



211.122 (160 mm)  
211.124 (300 mm)



Liseret décoratif  
211.130

Lames **ajourées**

Lames **semi-ajourées** dites en "s" ou "brise-vue"

Lames **pleines**

## Les décors personnalisés



Décor en tôle perforée



Découpe laser personnalisée



Hublot



Déco Alunox





Portail battant ou coulissant, clôture et garde-corps assortis, la gamme *nuances* rendra votre entrée unique.



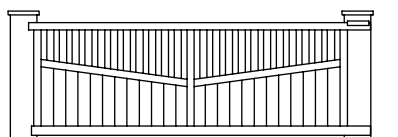

Datura

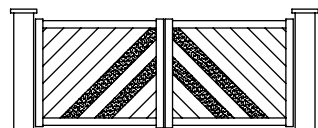

Photinia

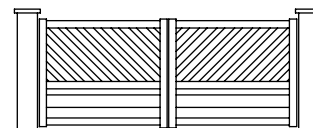

Sophora

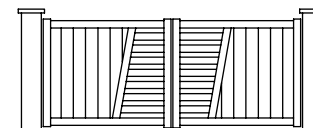

Coronille

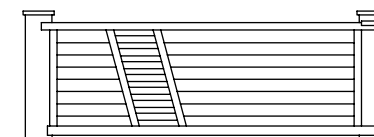

Yucca

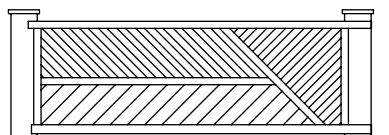

Pyracantha

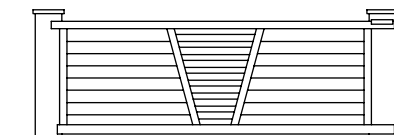

Ficus

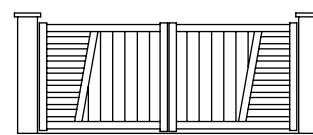

Potentille

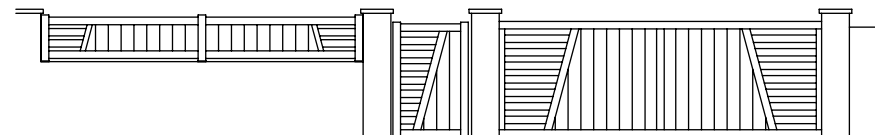

Cedrela

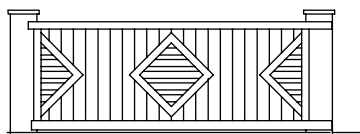

Maackia

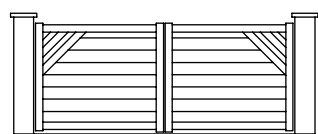

Weigelia simple

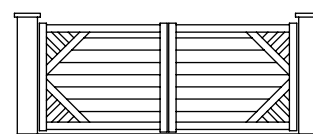

Weigelia double

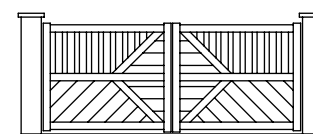

Ostrya



Gardenia

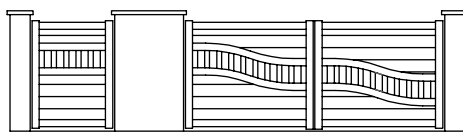

Stuartia

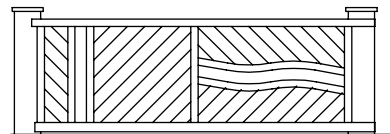

Laburnum

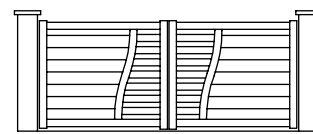

Argousier

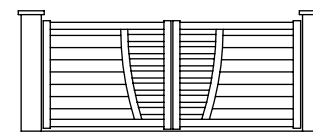

Kalanchoe

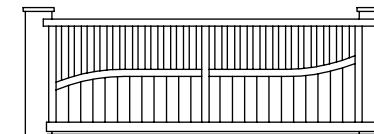

Parrotia

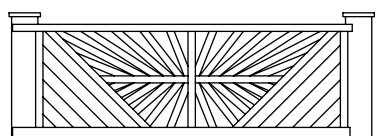

Calycanthe

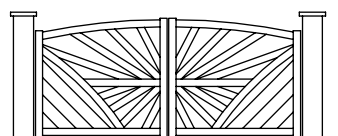

Magnolia

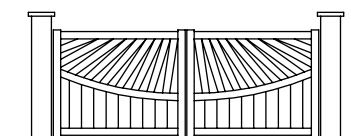

Spirée

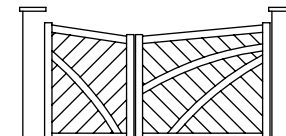

Seringat

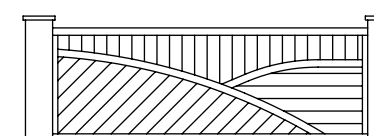

Halésia



## Le choix des formes

Portails battants  
(ouverture 50/50 ou 2/3-1/3)

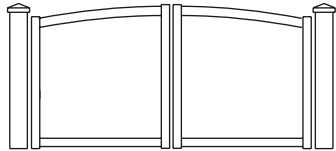

Cintré

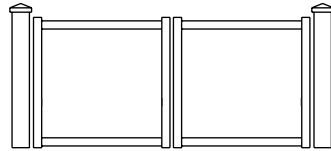

Droit

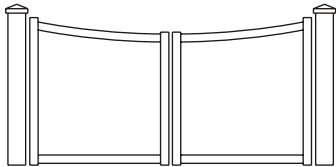

Cintré inversé

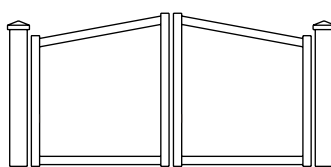

Oblique

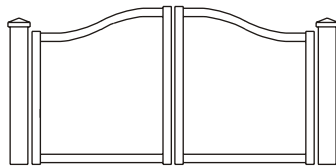

Chapeau de gendarme

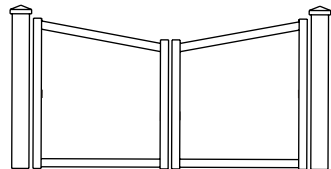

Oblique inversé

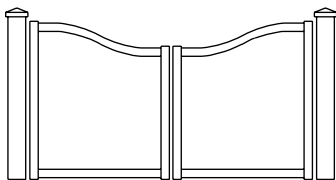

Chapeau de gendarme inversé

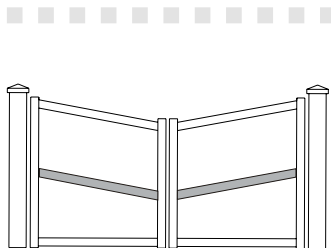

Toutes les formes peuvent être ajoutées en traverse intermédiaire

## Sens des lames

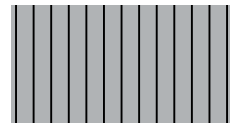

Verticales

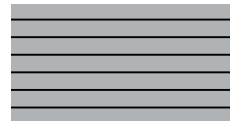

Horizontales

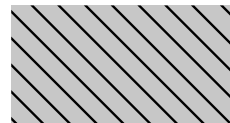

Biais



## Avantages techniques

Système de motorisation intégrée

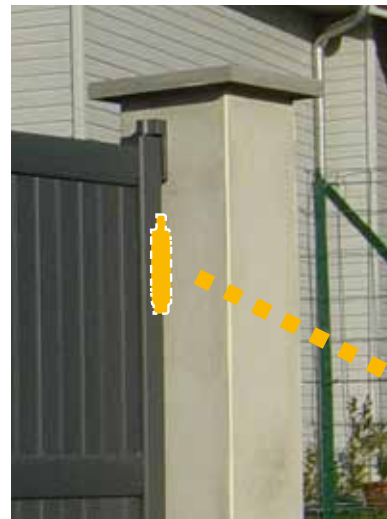

**somfy** Invisio

- Largeur vantail 2m50 maximum
- Déverrouillage **intérieur & extérieur** à la propriété
- Moteur électrique intégré 24 VDC
- Conforme à la **norme Européenne** EN 60335-2-103



Pour toutes les configurations d'ouverture :

- intérieure
- extérieure
- complète à 180°
- entre 2 murs



... POUR UN PORTAIL UNIQUE







Barreadée ou semi-ajourée, la gamme battante vous propose un vaste choix de lignes et modèles.

Lames droites ou inclinées, traverses en biais ou cintrées, donnent du caractère à votre portail.







## Les portails pleins

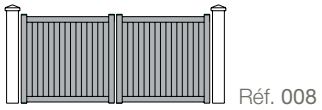

## Les portails à barreaudage

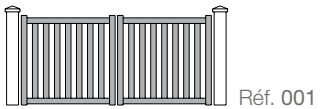

## Les portails mixtes

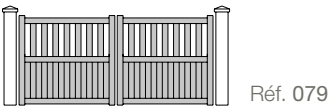

## Les portails pleins avec traverse et lames inclinées

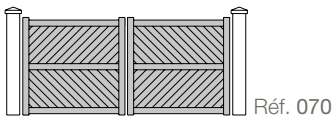

## Les portails pleins avec traverse

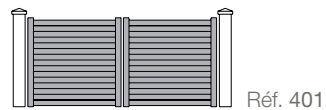
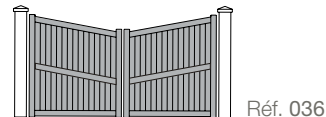
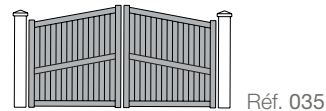
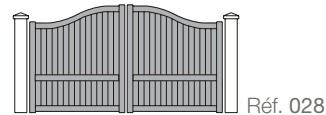
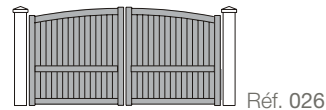
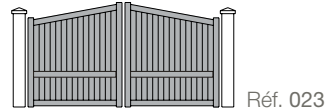
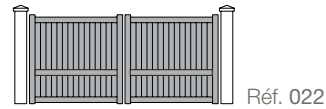

## Les portails mixtes avec traverse

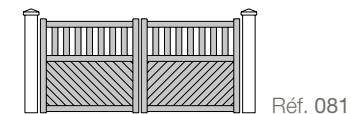
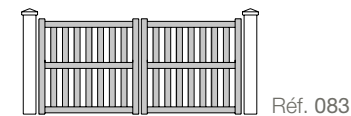
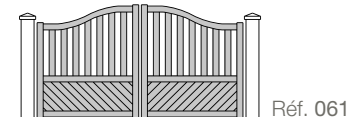
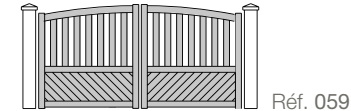
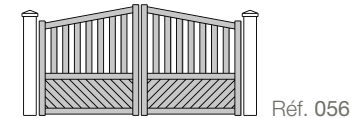
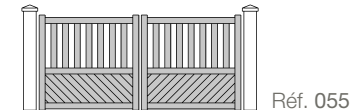
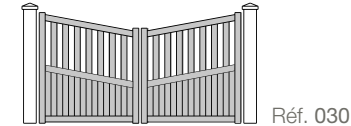
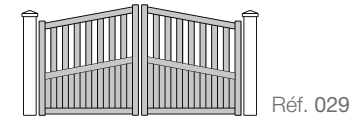
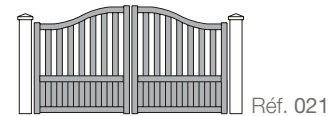
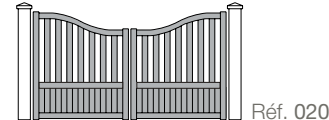
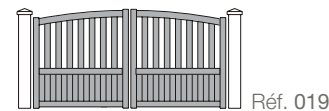
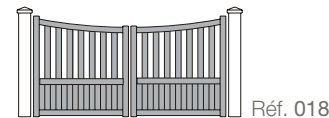
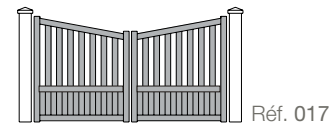
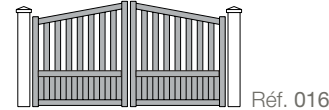
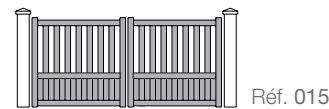

Choisissez la hauteur de votre traverse

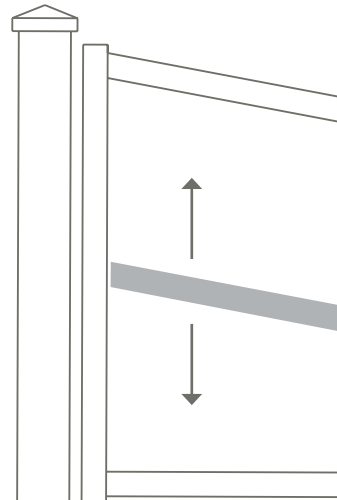



Tous nos portails battants sont déclinables en coulissants. Reposant sur son rail inox, le portail coulissant vous permet d'obtenir une grande ouverture.





Tous nos modèles battants sont **déclinables en coulissant**

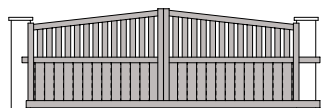

Réf. 116

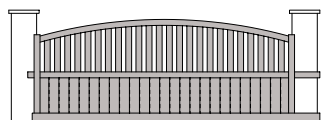

Réf. 119

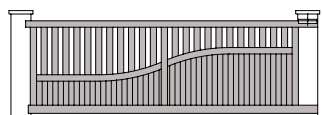

Réf. 200

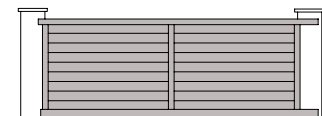

Réf. 459

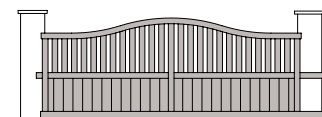

Réf. 76

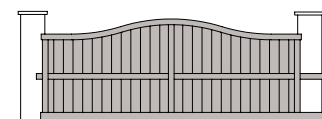

Réf. 45

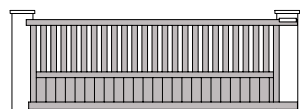

Réf. 43

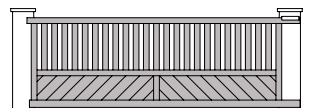

Réf. 47

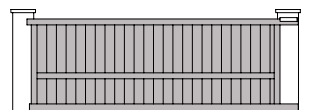

Réf. 44

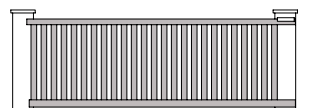

Réf. 41

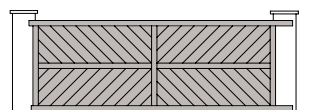

Réf. 88



Pensez à l'ouverture **coulissante en 2 vantaux**

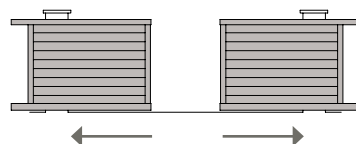



# PORTAILS STYLE FERRONNERIE



Le style ferronnerie permet de conférer un aspect traditionnel à votre entrée, tout en conservant les avantages de l'aluminium. Personnalisez votre portail avec un grand choix d'accessoires. Tous nos modèles sont déclinables en coulissants.





## Les modèles de portails

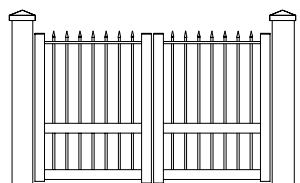

Réf. 301

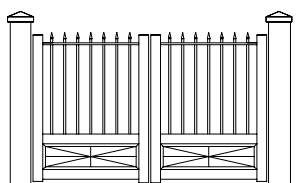

Réf. 302

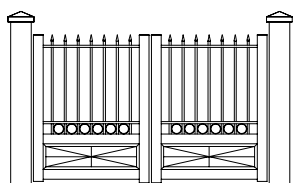

Réf. 306

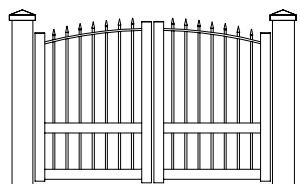

Réf. 366

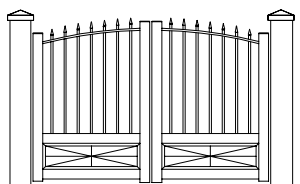

Réf. 367

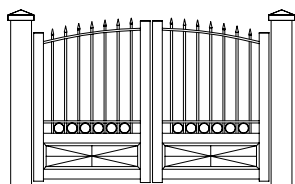

Réf. 371

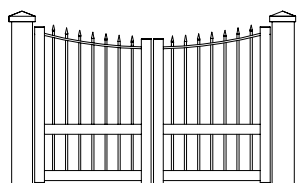

Réf. 381

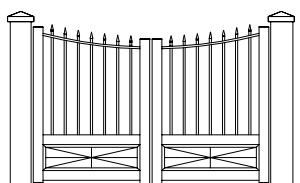

Réf. 382

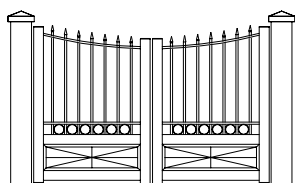

Réf. 386

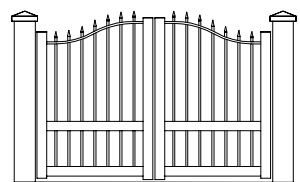

Réf. 351

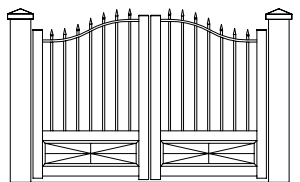

Réf. 352

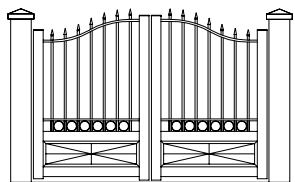

Réf. 356

## Les accessoires



Fleur de Lys



Fer de Lance



Pointe avec embase



Boule avec embase



Anneau décoratif



Rosace Ø 80mm



Rosace 400 x 210 mm



Palmette 460 x 230 mm



Volute à visser



Volute à poser



Volute en forme de six





Assortie au portail, la clôture aluminium apportera une touche d'élégance à votre propriété.







## Clôture ajourées ou pleines

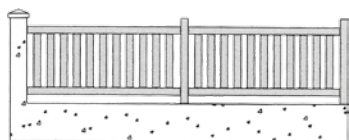

Réf. 970

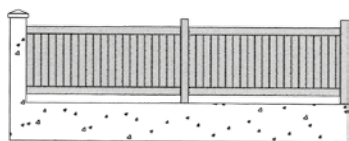

Réf. 971

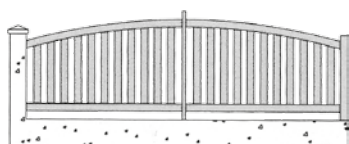

Réf. 972

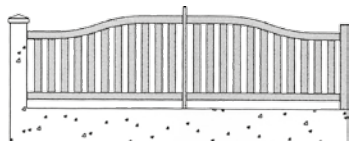

Réf. 973

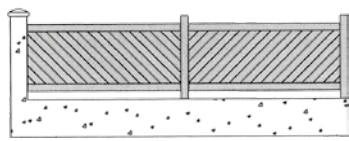

Réf. 976

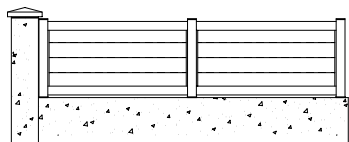

Réf. 951

## Clôture lisses horizontales

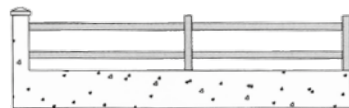

Réf. 955

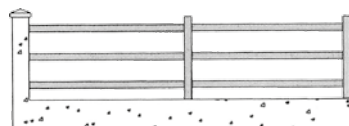

Réf. 960

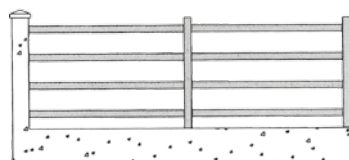

Réf. 980

## Clôture style **ferronnerie**

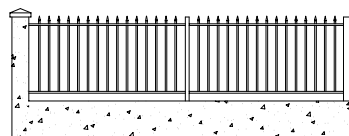

Réf. 920

## Platine de fixation

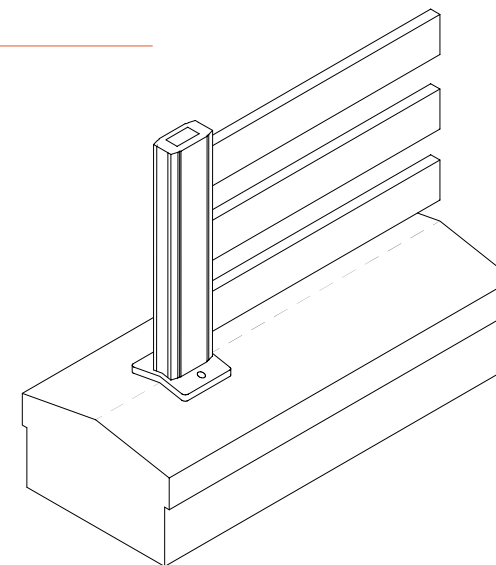



Pour sécuriser une terrasse, un balcon,  
un escalier,...

La gamme de garde-corps répondra à  
toutes vos exigences.







## Gardes-corps

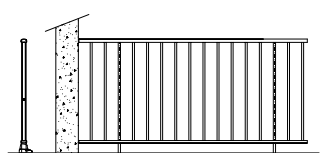

GC 01

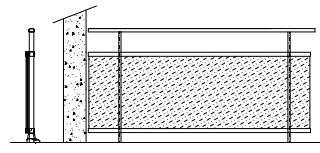

GC vitré

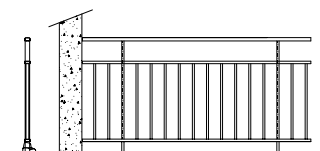

GC 02

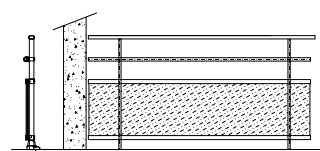

GC vitré  
+ 1 tube

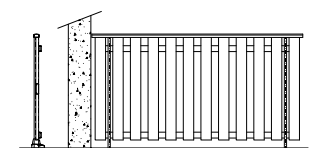

GC Palines

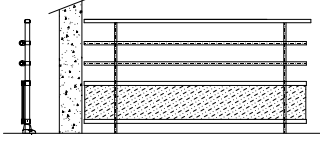

GC vitré  
+ 2 tubes

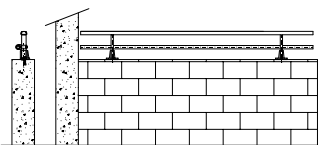

Appui  
Fenêtre  
+ 1 tube

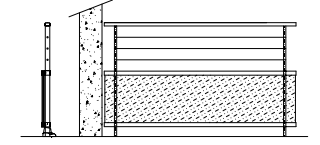

GC vitré  
avec câbles  
inox

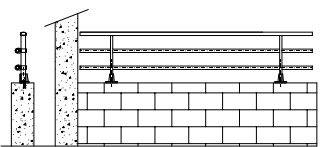

Appui  
Fenêtre  
+ 2 tubes

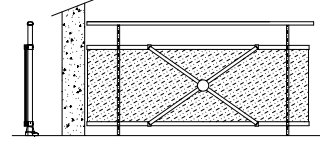

Croix  
de St-André

## Platine de fixation

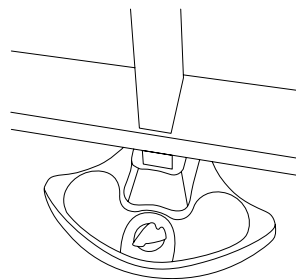

## Mode de fixation

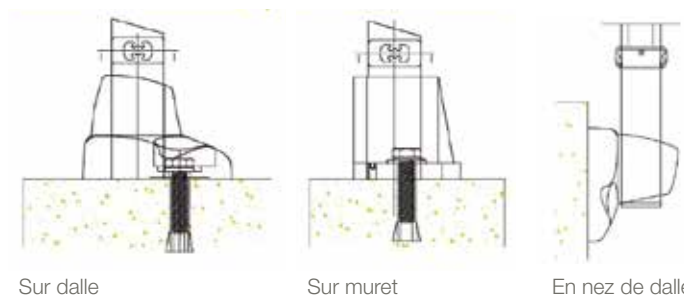

Sur dalle

Sur muret

En nez de dalle

## Style de remplissage



Tubes



Aspect lames bois (palines)



Câbles inox



Vitrage Clair ou Opale



Tôle pleine ou perforée



Vitrage teinté ou granité





En neuf comme en rénovation, le volet aluminium allie idéalement élégance et robustesse.

Il supprime les contraintes d'entretien pour l'utilisateur tout en gardant son aspect originel.





## Les formes de volet

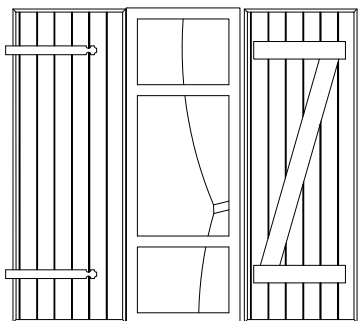

Volet plein barre écharpe

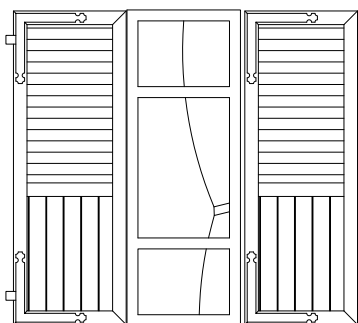

Volet mixte

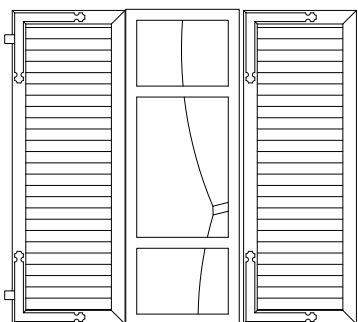

Volet persienne

## Coupes

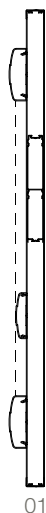

01 Volet plein avec barres / écharpes

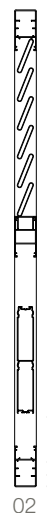

02 Volet mixte



03 Volet persienne ajouré



04 Volet aspect persienne



05 Volet persienne orientable



# CGA

portails aluminium

- GAMME NUANCES
- PORTAILS BATTANTS
- PORTAILS COULISSANTS
- PORTAILS STYLE FERRONNERIE
- CLÔTURES
- GARDE-CORPS
- VOLETS BATTANTS

CGA portails aluminium

147 route de Melay  
42720 Briennon

Tél. 04 77 60 72 43  
Fax 04 77 60 96 92

[contact@portailalucga.com](mailto:contact@portailalucga.com)

[www.portailalucga.com](http://www.portailalucga.com)



LAQUAGE  
GARANTI  
**10** ANS



VOTRE INSTALLATEUR CONSEIL

